

## Mikro sedežni ventili 3/2 serija PRAM



### SIMBOL



MODEL	PRAM3
MEDIJ	Filtriran zrak 20 $\mu$
AKTIVIRANJE	Zunanje aktiviranje
VELIKOST PRIKLJUČKA	G 1/8
NAZIVNI PRESEK	2.5 mm <sup>2</sup>
NAZIVNI PRETOK	Qn=138 NI/min
TIP VENTILA	3 priključki 2 položaja (3/2)
DELOVNI TLAK	0 - 10 bar
PREIZKUSNI TLAK	15 bar
TEMPERATURNO OBMOČJE	-20 / +70°C
MATERIAL OHIŠJA	Aluminij

### KODA ZA NAROČILO

MODEL	VELIKOST	TIP VENTILA	NADGRADNJA
PRAM3	04 - G 1/8	32 - 3 priključki 2 položaja (3/2) 53 - 5 priključkov 3 položaji (5/3) - samo PA nadgradnja	/ - brez nadgradnje AK - pokončno kolesce AR - stikalo AKV - kolesce AQV - klecno kolesce T - gumb raven TD - gumb dvignjen TG - gumb gobast PA - preklopnik TG40 - gumb gobast z zaščito TG75 - gumb gobast z zaščito TGZ - gumb gobast zaskočni (samo rdeč)

### DIMENZIJE

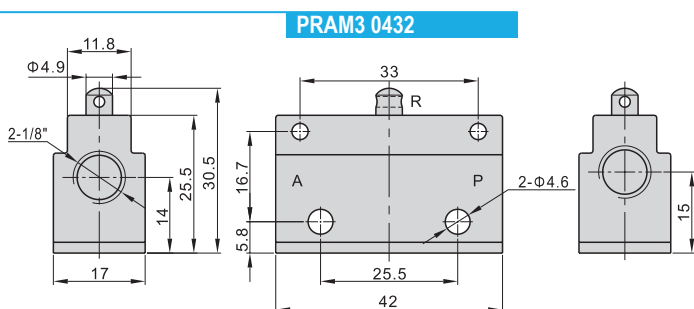

### AKV - KOLESCA

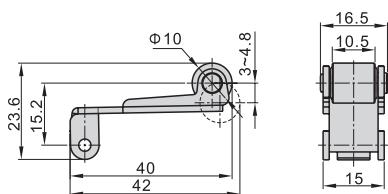

### AQV - KLEČNO KOLESCA

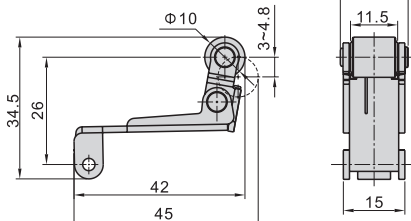

### AR - STIKALO

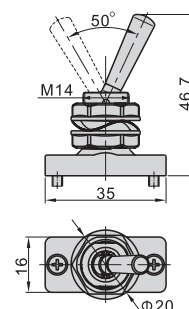

### AK - POKONČNO KOLESCJE

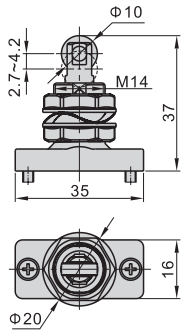

### TG (R, G, B, Y) - GUMB GOBAST

Gumb: rdeč, zelen, črn, rumen

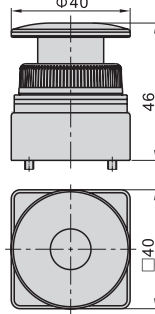

### TD (R, G, B, Y) - GUMB DVIGNJEN

Gumb: rdeč, zelen, črn, rumen

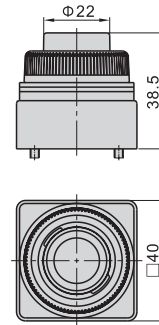

### T (R, G, B, Y) - GUMB RAVEN

Gumb: rdeč, zelen, črn, rumen

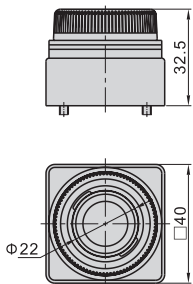

### PA (R, G, B, Y) - PREKLOPNIK

Gumb: rdeč, zelen, črn, rumen

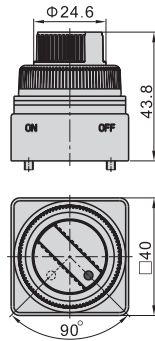

### TGZ - GUMB GOBAST ZASKOČNI

Gumb: rdeč

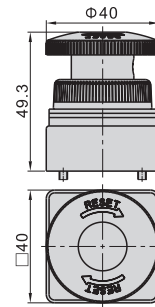

### TG40 (R, G, B, Y) - GUMB GOBAST Z ZAŠČITO

Gumb: rdeč, zelen, črn, rumen

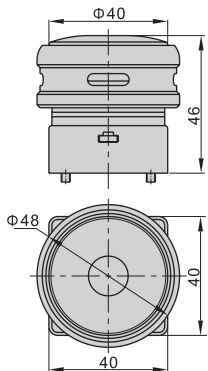

### TG75 (R, G, B, Y) - GUMB GOBAST Z ZAŠČITO

Gumb: rdeč, zelen, črn, rumen

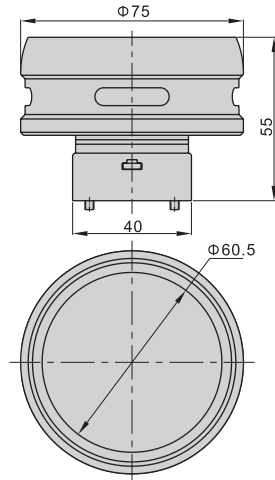

### PRAM3 0453 PA (R, G, B, Y) - PREKLOPNIK

Gumb: rdeč, zelen, črn, rumen

